

GOODWE



User Manual

Micro Inverter

V1.4-2026-05-20

Copyright ©GoodWe Technologies Co.,Ltd. 2024. All rights reserved.

No part of this manual can be reproduced or transmitted to the public platform in any form or by any means without the prior written authorization of GoodWe Technologies Co.,Ltd.

Trademarks

GOODWE and other GOODWE trademarks are trademarks of GoodWe Technologies Co.,Ltd. All other trademarks or registered trademarks mentioned in this manual are owned by the company.

NOTICE

The information in this user manual is subject to change due to product updates or other reasons. This manual cannot replace the safety instructions or labels on the equipment unless otherwise specified. All descriptions here are for guidance only.

CONTENT

- 1 About This Manual 1**
 - 1.1 Applicable Model..... 1
 - 1.2 Target Audience..... 1
 - 1.3 Symbol Definition 1
- 2 Safety Precaution..... 2**
 - 2.1 General Safety 2
 - 2.2 PV String Safety 2
 - 2.3 AC Side 3
 - 2.4 Inverter Safety 3
 - 2.5 Personal Requirements 4
 - 2.6 EU Declaration of Conformity 4
- 3 Product Introduction 5**
 - 3.1 Product Overview 5
 - 3.2 Supported Grid Types 5
 - 3.3 Features 6
 - 3.4 Circuit Diagram..... 7
 - 3.5 Appearance 8
 - 3.5.1 Parts..... 8
 - 3.5.2 Dimensions 8
 - 3.5.3 Indicators 9
 - 3.5.4 Nameplate 9
- 4 Check and Storage 10**
 - 4.1 Check Before Receiving 10
 - 4.2 Deliverables..... 10
 - 4.3 Storage 11
- 5 Installation 12**
 - 5.1 Installation Requirements..... 12
 - 5.2 Inverter Installation 14
 - 5.2.1 Moving the Inverter 14
 - 5.2.2 Installing the Inverter 15
- 6 Electrical Connection 18**

6.1 Safety Precaution	18
6.2 System Network Diagram	18
6.3 Connecting the PE Cable	19
6.4 Connecting the AC Output Cable	20
6.5 Connecting the PV Input Cable	24
7 Equipment Commissioning	26
7.1 Check Before Power ON	26
7.2 Power On.....	26
8 System Commissioning	27
8.1 Indicators	27
8.2 Setting Inverter Parameters via App	28
8.3 Monitoring via SEMS Portal	28
9 Maintenance	29
9.1 Power Off the Inverter	29
9.2 Removing the Inverter.....	29
9.3 Disposing of the Inverter	30
9.4 Troubleshooting	30
9.5 Routine Maintenance.....	36
10 Technical Parameters	37
11 Appendix	40

1 About This Manual

This manual describes the product information, installation, electrical connection, commissioning, troubleshooting, and maintenance. Read through this manual before installing and operating the product. All the installers and users have to be familiar with the product features, functions, and safety precautions. This manual is subject to update without notice. For more product details and latest documents, visit <https://en.goodwe.com/>.

1.1 Applicable Model

This manual applies to the listed inverters below (MIS for short):



Model	Nominal Output Power	Nominal Output Voltage
GW1600-MIS	1600W	220/230/240
GW1800-MIS	1800W	
GW2000-MIS	2000W	

1.2 Target Audience

This manual applies to trained and knowledgeable technical professionals. The technical personnel has to be familiar with the product, local standards, and electric systems.

1.3 Symbol Definition

Different levels of warning messages in this manual are defined as follows:

 DANGER
Indicates a high-level hazard that, if not avoided, will result in death or serious injury.
 WARNING
Indicates a medium-level hazard that, if not avoided, could result in death or serious injury.
 CAUTION
Indicates a low-level hazard that, if not avoided, could result in minor or moderate injury.
NOTICE
Highlights key information and supplements the texts. Or some skills and methods to solve product-related problems to save time.

2 Safety Precaution

WARNING

- The inverters are designed and tested strictly complies with related safety rules. Read and follow all the safety instructions and cautions before any operations. Improper operation might cause personal injury or property damage as the inverters are electrical equipment.
- It is expressly recommended to use rapid shutdown methods, systems or devices on the d.c. circuit that guarantee safety in firefighting situations.

2.1 General Safety

NOTICE

- The information in this user manual is subject to change due to product updates or other reasons. This manual cannot replace the safety instructions or labels on the equipment unless otherwise specified. All descriptions here are for guidance only.
- Before installations, read through the manual for product information and installation precautions.
- All operations should be performed by trained and knowledgeable technicians who are familiar with local standards and safety regulations.
- Use insulating tools and wear personal protective equipment when operating the equipment to ensure personal safety. Wear anti-static gloves, cloths, and wrist strips when touching electron devices to protect the inverter from damage.
- Strictly follow the installation, operation, and configuration instructions in this manual. The manufacturer shall not be liable for equipment damage or personal injury if you do not follow the instructions. For more warranty details, please visit <https://en.goodwe.com/warranty>.

2.2 PV String Safety

DANGER

When connecting the PV input cable, make sure that the PV connector model matches the PV connector model on the inverter side. The manufacturer shall not be liable for the equipment damage if other connectors are used.

WARNING

- Ensure the component frames and the bracket system are securely grounded.
- Ensure that the positive or negative poles of PV module do not short-circuit to the ground. Otherwise, severe damage might happen, which is beyond the manufacturer's liability.
- Ensure the DC cables are connected tightly, securely and correctly.
- Ensure that the voltage of the PV module is within the permissible range of the inverter.
- Connect one PV module to each input of the inverter. Do not connect the battery or other power source to the inverter input.

2.3 AC Side











⚠ WARNING

- The voltage and frequency at the connection point meet the on-grid requirements.
- Additional protective devices like circuit breakers or fuses are recommended on the AC side. Specification of the protective device should be at least 1.25 times the maximum AC output current.
- Make sure that all the grounding cables are tightly connected. When there are multiple inverters, make sure that all the grounding points on the enclosures are equipotential connected.

2.4 Inverter Safety

⚠ DANGER

- All labels and warning marks should be visible after the installation. Do not scrawl, damage, or cover any label on the device.
- Unauthorized dismantling or modification may damage the equipment, the damage is not covered under the warranty.
- Do not touch the running equipment to avoid being hurt as its temperature may exceed 60°C. Do not install the equipment at a place within children's reach.
- Install the product away from electromagnetic interference. Install the product away from electromagnetic interference. If there is any radio or wireless communication equipment below 30MHz near the equipment, you have to:
 - Add a low pass EMI filter or a multi winding ferrite core to the DC input cable or AC output cable of the inverter.
 - Install the inverter at least 30m far away from the wireless equipment.
- Warning labels on the inverter are as follows.

	High-temperature hazard. Do not touch the product under operation to avoid being burnt.		Delayed discharge. Wait 5 minutes after power off until the components are completely discharged.
	Read through the user manual before any operations.		Potential risks exist. Wear proper Personal Protective Equipment before any operations.
	Do not dispose of the inverter as household waste. Discard the product in compliance with local laws and regulations, or send it back to the manufacturer.		Grounding point
	CE mark		TÜV mark
	RCM mark		ANATEL mark

2.5 Personal Requirements

NOTICE

- Personnel who install or maintain the equipment must be strictly trained, learn about safety precautions and correct operations.
- Only qualified professionals or trained personnel are allowed to install, operate, maintain, and replace the equipment or parts.

2.6 EU Declaration of Conformity

GoodWe Technologies Co., Ltd. hereby declares that the inverter with wireless communication modules sold in the European market meets the requirements of the following directives:

- Radio Equipment Directive 2014/53/EU (RED)
- Restrictions of Hazardous Substances Directive 2011/65/EU and (EU) 2015/863 (RoHS)
- Waste Electrical and Electronic Equipment 2012/19/EU
- Registration, Evaluation, Authorization and Restriction of Chemicals (EC) No 1907/2006 (REACH)

You can download the EU Declaration of Conformity on <https://en.goodwe.com>.

3 Product Introduction

3.1 Product Overview

The MIS inverter is a micro single-phase grid-tied PV inverter. The inverter converts the DC power generated by the PV module into AC power and feeds it into the utility grid. The intended use of the inverter is as follows:

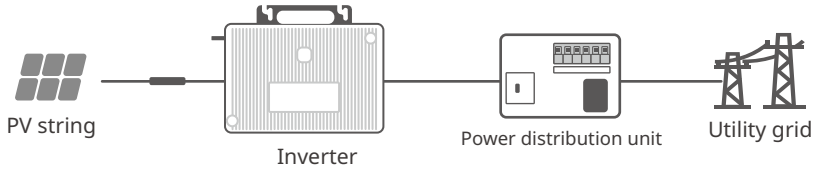

3.2 Supported Grid Types

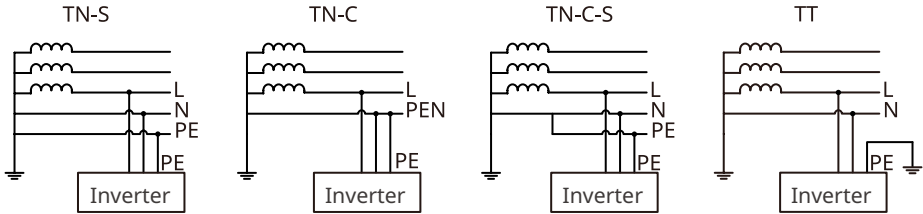

3.3 Features

Module level monitoring

The inverter supports 4 independent Maximum Power Point Tracking (MPPT for short). Each MPPT is connected to one PV module and tracks the maximum power point of each module.

Power derating

To satisfying the local laws or regulations and ensuring a safe operation, the inverter will automatically reduce the output power when the operating environment is not ideal. The following are the factors that may occur power derating. Please try to avoid then during operations.

- Unfavorable environmental conditions, e.g., direct sunlight, high temperature, etc.
- Inverter's output power percentage has been set.
- Over-frequency derating.
- Higher input voltage value.
- Higher input current value.

Communication

Setting the inverter via bluetooth in a short distance; or connecting the inverter to the server via WiFi to monitor the inverter and power plant working status.

- Bluetooth: meets Bluetooth 5.0 standard.
- WiFi: supports 2.4G frequency band. Set the router to 2.4G or 2.4G/5G mode.
- The router wireless signal name supports a maximum input of 32 bytes.
- To ensure communication quality, it is recommended to select a router with high wireless gain or more antennas. Use a wireless repeater or outdoor router if needed.
- Check the WiFi signal intensity via SolarGo app. It is recommended to move the router closer to the inverter or clear the signal blocking objects to enhance the signal intensity when it is less than 50.

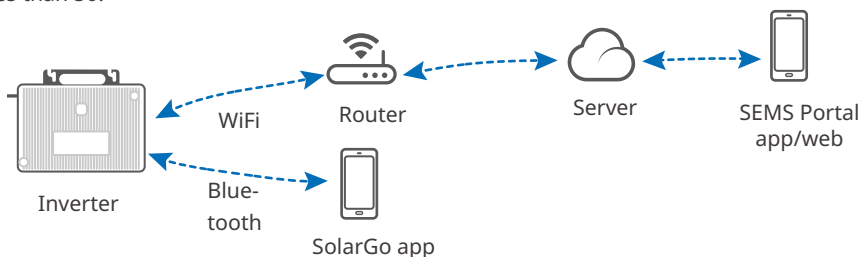

When multiple inverters are connected, these inverters can form a tree network via WiFi and communicate with the server through the one selected as the communication root node. Specify one inverter as the communication root node via SolarGo app if the communication is poor. For more detailed instructions, refer to the SolarGo APP User Manual

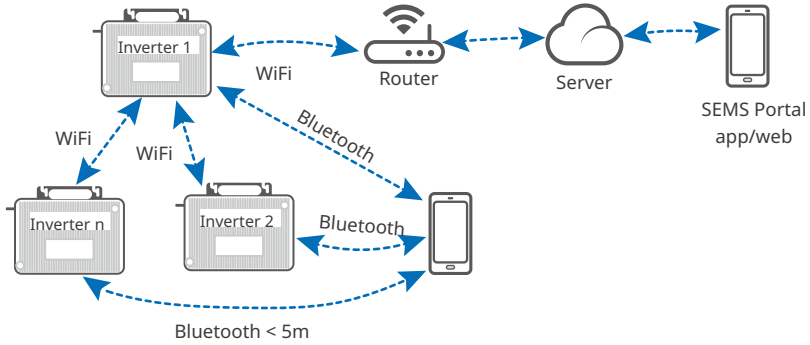

The inverter can communicate with the EzLogger 3000R product for functions such as power limit, remote shutdown, etc. For more detailed instructions, refer to the user manual of EzLogger 3000R.

RSD (optional)

- In a rapid shutdown system, RSD can maintain PV module's output by receiving signals from a transmitter. The transmitter is external to the inverter. When an emergency occurs, the transmitter can be stopped by enabling an external trigger device, which in turn stops the RSD output and turns off the PV module.
- Supported RSD transmitter: GTP-F2L-20 ou GTP-F2M-20
Supported RSD receiver: GR-B1F-20 ou GR-B2F-20

3.4 Circuit Diagram

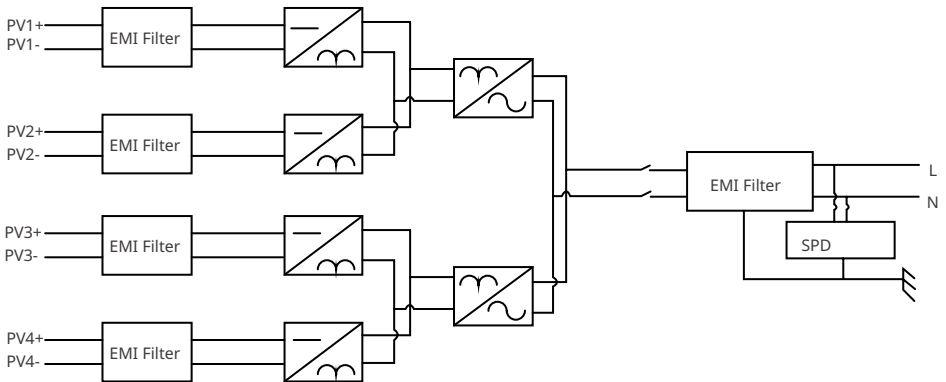

3.5 Appearance

3.5.1 Parts

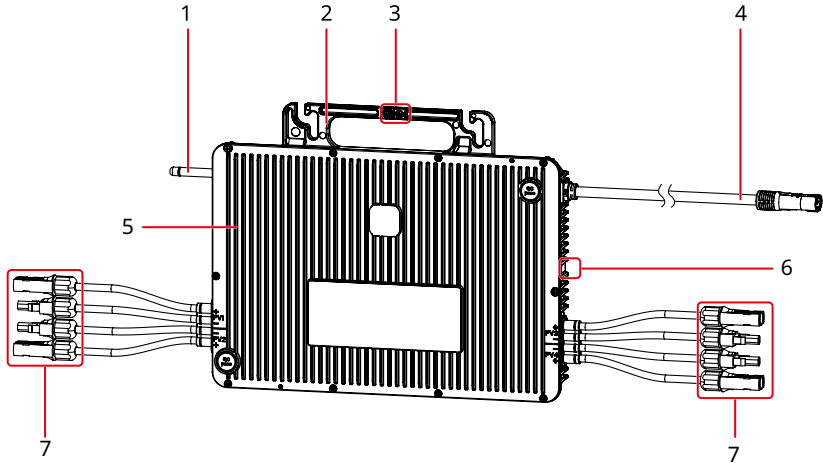

No.	Parts	Description
1	Antenna	Wireless communication; supports WiFi.
2	Handle	Moves or hangs the inverter.
3	Grounding Point	Connects grounding cables to the grounding points for protection.
4	AC connector	Connects the AC branch of the inverter to the trunk cable.
5	Heat sink	Used to cool the inverter.
6	LED Indicators	Indicates working state of the inverter.
7	PV connector	Connects the inverter to the PV module.

3.5.2 Dimensions

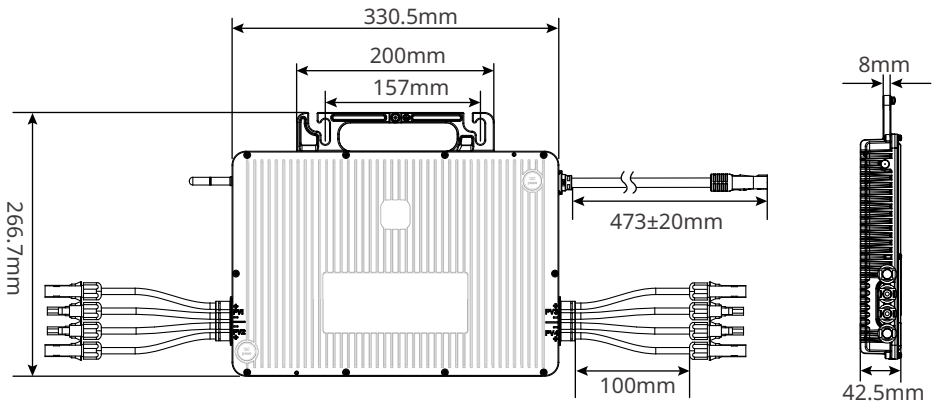

3.5.3 Indicators

Indicator status	Descriptions
	Slow blinking green = Equipment on and in the standby mode.
	Fast blinking green = equipment starting and in the self-check mode.
	Steady green = The four PV inputs are available, and the inverter is feeding power to the grid properly.
	Blinking green and red = Not all PV inputs are available, but the inverter is still feeding power to the grid. The four blinks represent the status of four inputs PV1, PV2, PV3 and PV4 respectively. Red blinks indicating abnormal PV input, green blinks indicating normal PV input. Example: As shown on the left, PV1 is abnormal and PV2, PV3 and PV4 are normally working.
	Single blinking red = Utility grid loss.
	Double blinking red = Utility grid fault.
	Steady red = Equipment fault.
	Fast blinking green and red = Updating software.

3.5.4 Nameplate

The nameplate is for reference only.

GOODWE

Product: Micro Inverter
Model: GW*-MIS**

PV Input	UDCmax: ** Vd.c. UMPP: ** Vd.c.	
	IDCmax: ** Ad.c. ISC PV: ** Ad.c.	
Output	UAC,r: *** Va.c. fAC,r: ** Hz	S/N: <div style="font-size: 8px; margin-top: 10px;"> ***** Co., Ltd E-mail: *****@****.com ***** </div>
	PAC,r: **** W Sr: **** VA	
	Smax: **** VA	
	IAC,max: ***	
P.F.: ~**...**ind, Toperating: ** °C Galvanically Isolate d HF Transforme r, IP67, Protectiv e Clas s I OVC DCII/ACIII		S/N

GW trademark, product type and product model

Safety symbols and certification marks

Contact information and serial number

Technical parameters

4 Check and Storage

4.1 Check Before Receiving

- Check the following items before receiving the product.
- Check the outer packing box for damage, such as holes, cracks, deformation, and other signs of equipment damage. Do not unpack the package and contact the supplier as soon as possible if any damage is found.
- Check the inverter model. If the inverter model is not what you requested, do not unpack the product and contact the supplier.
- Check the deliverables for correct model, complete contents, and intact appearance. Contact the supplier as soon as possible if any damage is found.

4.2 Deliverables

NOTICE

- Connect the PV cables using the PV connectors in correct model. The manufacturer shall not be liable for the damage if other connectors are used.
- The actual number of accessories may differ.
- The T shape AC connector and its accessories used in different regions are different.
- The optional accessories can be purchased from the manufacturer based on your actual needs. The accessories will be delivered separately.

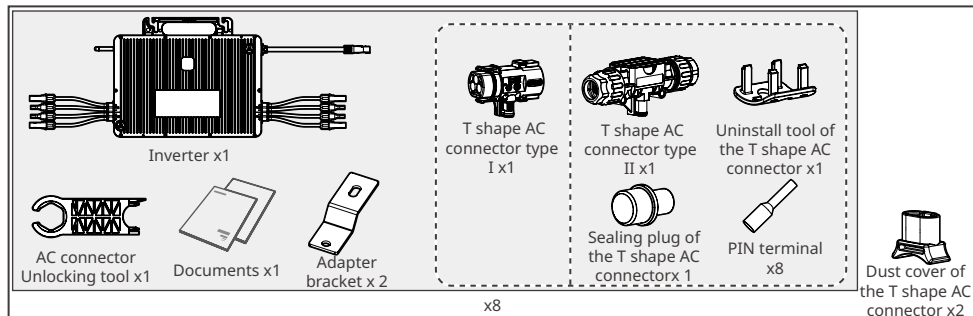

Optional accessory

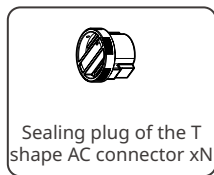
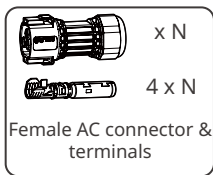
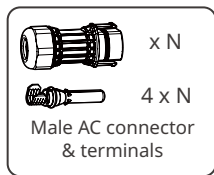
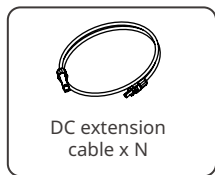

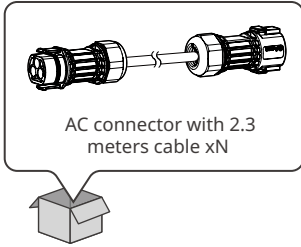

The length and specifications of DC and AC extension cable are different, please choose according to actual needs. Please refer to the table below for details.

Cable	Specifications		
DC extension cable	MC4, 12AWG, 1m	MC4, 12AWG, 2m	MC4, 12AWG, 4m
AC extension cable	TC-ER, 10AWG/3C, 2.3m	TC-ER, 10AWG/3C, 4.6m	-

4.3 Storage

If the equipment is not to be installed or used immediately, please ensure that the storage environment meets the following requirements:

1. Do not unpack the outer package or throw the desiccant away.
2. Store the equipment in a clean place. Make sure the temperature and humidity are appropriate and no condensation.
3. The height and direction of the stacking inverters should follow the instructions on the packing box.
4. The inverters must be stacked with caution to prevent them from falling.
5. The storage time of the inverter should not exceed two years. If the storage time exceeds two years, it must be inspected and tested by professionals before being put into use.

5 Installation

5.1 Installation Requirements

Installation Environment Requirements

1. Do not install the equipment in a place near flammable, explosive, or corrosive materials.
2. Install the equipment on a surface that is solid enough to bear the inverter weight.
3. Install the equipment in a well-ventilated place to ensure good dissipation. Also, the installation space should be large enough for operations.
4. The equipment with a high ingress protection rating can be installed outdoors. The temperature and humidity at the installation site should be within the appropriate range.
5. Install the equipment in a sheltered place to avoid direct sunlight, rain, and snow.
6. Do not install the equipment in a place that is easy to touch, especially within children's reach. High temperature exists when the equipment is working. Do not touch the surface to avoid burning.
7. Install the equipment at a height that is convenient for operation and maintenance, electrical connections, and checking indicators and labels.
8. Install the product away from electromagnetic interference. Install the equipment away from electromagnetic interference. If there are radio stations or wireless communication equipment below 30 MHz near the installation location, install the equipment as follows:
 - Add a multi-turn winding ferrite core at the DC input line or AC output line of the inverter, or add a low-pass EMI filter.
 - Install the inverter at least 30m far away from the wireless equipment.

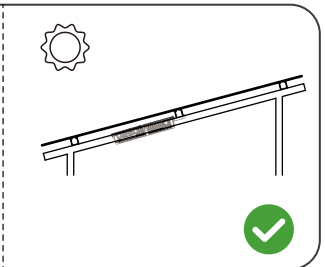
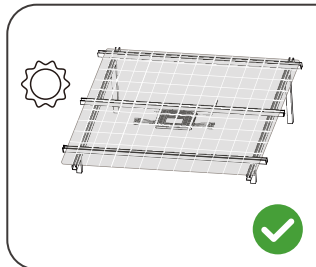
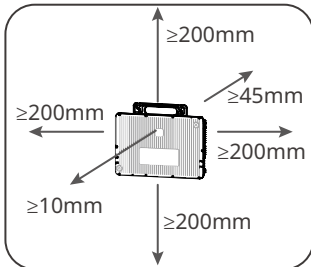
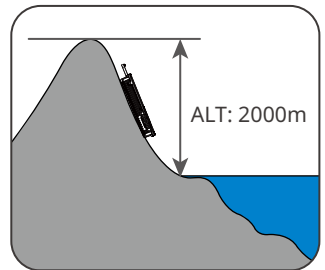

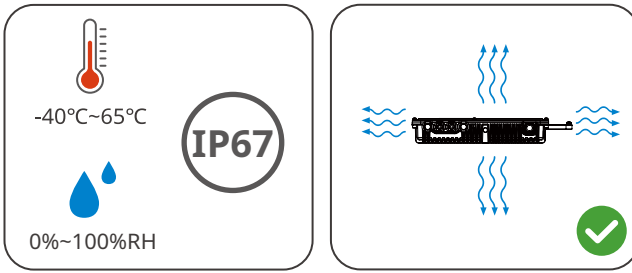

Mounting Support Requirements

- Install the inverter on the PV racking.
- The mounting support shall be nonflammable and fireproof.
- Ensure the PV racking is solid enough to bear the inverter weight.
- Do not install the product on the support with poor sound insulation to avoid the noise generated by the working product, which may annoy the residents nearby.

Installation Angle Requirements

- Mounting the inverter tilt with the angle of the PV module securely.
- Ensure that the installation angle meets the ventilation and dissipation requirements.

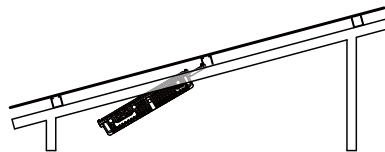
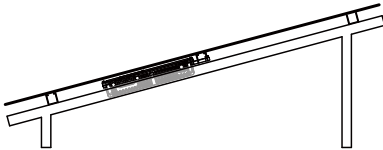
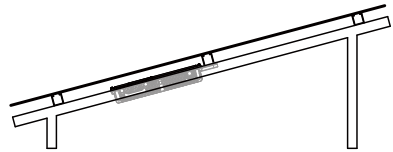
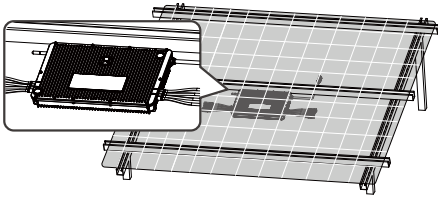

Installation Tool Requirements

The following tools are recommended when installing the equipment. Use other auxiliary tools on site if necessary.

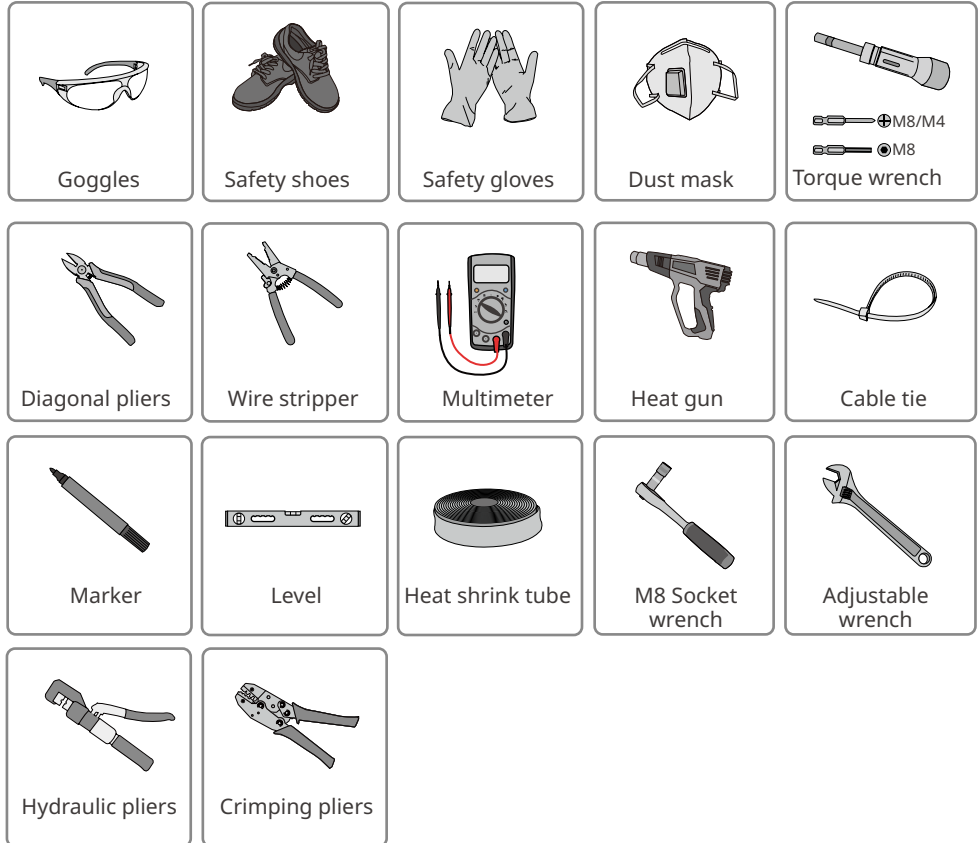

5.2 Inverter Installation

5.2.1 Moving the Inverter

CAUTION

Move the inverter to the site before installation. Follow the instructions below to avoid personal injury or equipment damage.

1. Consider the weight of the equipment before moving it. Assign enough personnel to move the equipment to avoid personal injury.
2. Wear safety gloves to avoid personal injury.
3. Keep balance to avoid falling down when moving the equipment.
4. Do not bump or hit the antenna. Otherwise, the antenna may be damaged.
5. Instead of lifting the cables directly, it is recommended to hold the handle of the inverter to prevent potential damage to the cables.

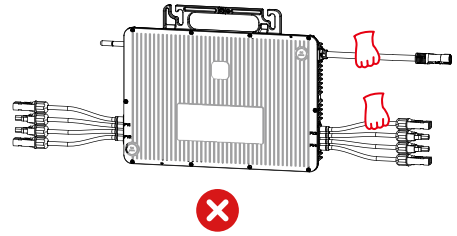
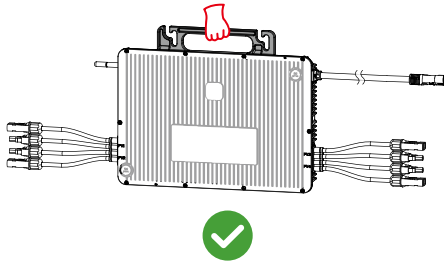

5.2.2 Installing the Inverter

NOTICE

- Plan the installation positions of the inverters and PV modules before installation.
- Install the inverter on the rail. Prepare aluminum clamps to fix the installation screws when the holes on the rail are not suitable for installing the inverter.
- Wear goggles and a dust mask to prevent the dust from being inhaled or contacting eyes when drilling holes.
- M8 screws should be prepared by customers. Prepare the screws, especially the screw length, in accordance with the dimension of the rail and thickness of the inverter handle (8mm).

Install the inverter without adapter bracket

The following installation is recommended when the distance between the PV module and rail is larger than 30mm.

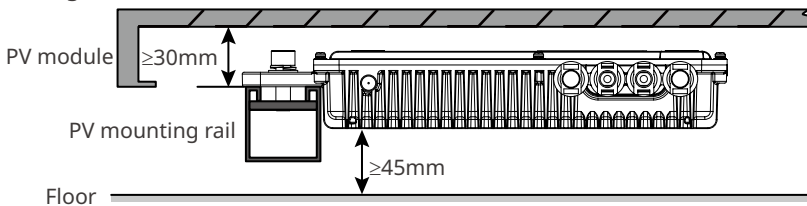

The following installation is recommended when the distance between the PV module and rail is less than 30mm and the distance between the rail and the floor is sufficient.

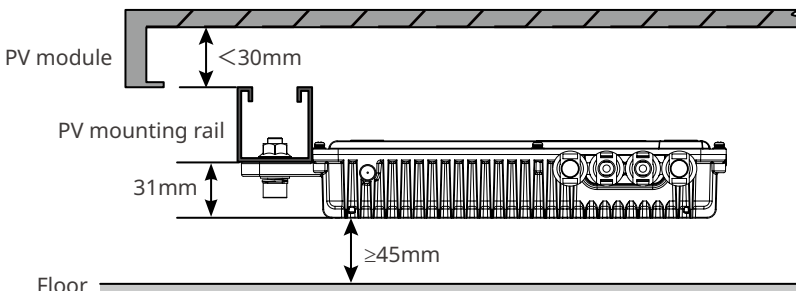

In this method, you need to unscrew the grounding screw of the handle before installing inverter.

Step 1 Fix the M8 screws on the rail and reserve a certain length for hanging the inverter.

Step 2 Hang the inverter on the screws

Step 3: Push the handle gently to secure the inverter.

Step 4 Tighten the screws. Ensure that the inverter is fixed properly and securely.

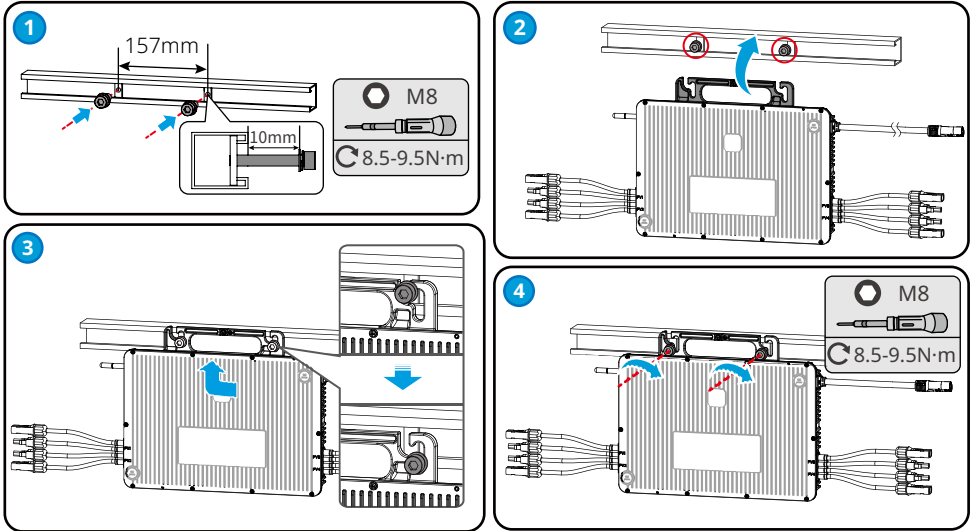

Install the inverter with adapter bracket

The following installation is recommended when the distance between the PV module and rail is between 16mm and 30mm, or the inverter cannot install without the adapter bracket.

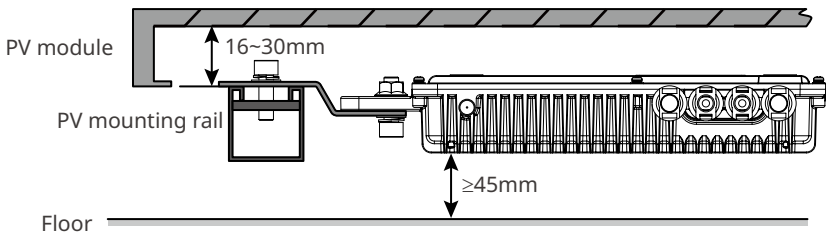

Step 1 Fix the M8 screws on the rail and adapter bracket respectively. Reserve a certain length for hanging the inverter.

Step 2 Hang the inverter on the screws

Step 3: Push the handle gently to secure the inverter.

Step 4 Tighten the screws. Ensure that the inverter is fixed properly and securely.

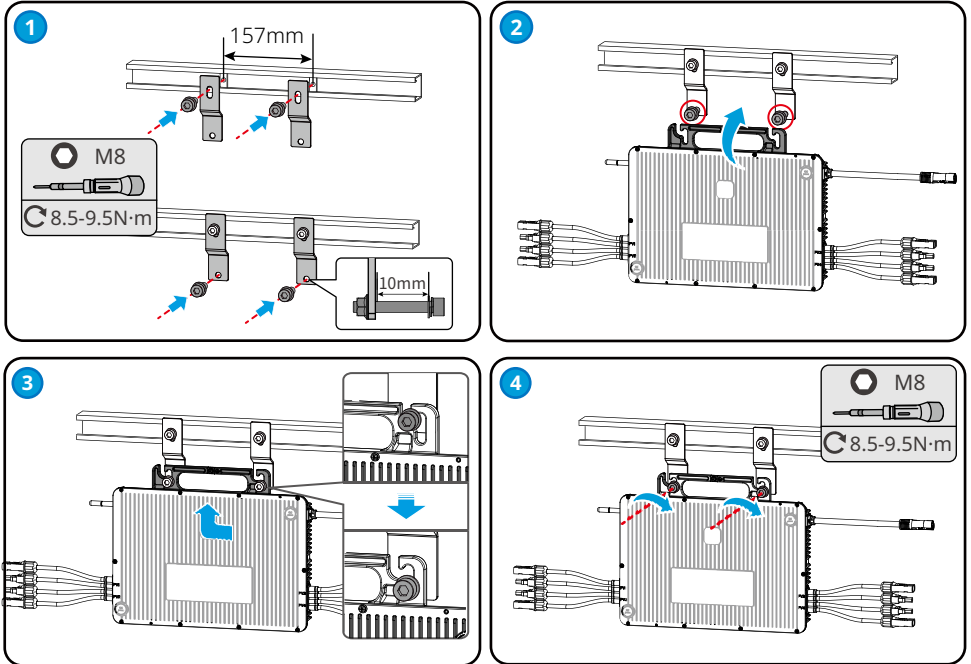

6 Electrical Connection

6.1 Safety Precaution

DANGER

- Disconnect the PV connectors and the AC output switch of the inverter to power off the inverter before any electrical connections. Do not work with power on. Otherwise, an electric shock may occur.
- Perform electrical connections in compliance with local laws and regulations. Including operations, cables, and component specifications.
- If the cable bears too much tension, the connection may be poor. Reserve a certain length of the cable before connecting it to the inverter

NOTICE

- Wear personal protective equipment like safety shoes, safety gloves, and insulating gloves during electrical connections.
- All electrical connections should be performed by qualified professionals.
- Cable colors in this document are for reference only. The cable specifications shall meet local laws and regulations.
- The inverter must be licensed by the electricity authority of the country/region in which it is located before it can be connected to the grid.

6.2 System Network Diagram

NOTICE

- Prepare cables based on installation plan before electrical connections.
- After installing the inverters, peel the removable serial number label from the micro inverter and affix it on a paper to create a installation map. Or add the layout via SEMS Portal web to monitor the working status of the inverters.

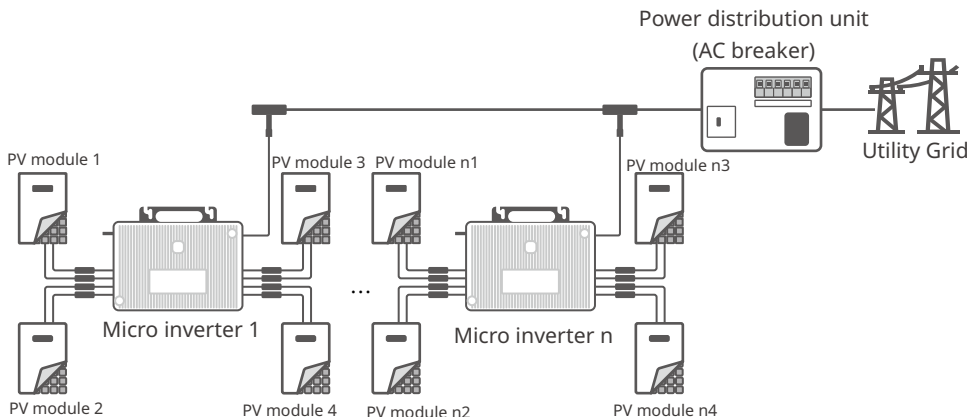

6.3 Connecting the PE Cable

⚠ WARNING

- Both the grounding points on the enclosure and AC cable are recommended.
- Make sure that all the grounding points on the enclosures are equipotential connected when there are multiple inverters.
- To improve the corrosion resistance of the terminal, you are recommended to apply silica gel or paint on the ground terminal after installing the PE cable.
- The PE cable should be prepared by the customer. Recommended specifications: 6mm² (10AWG).
- The M4 grounding OT terminal should be prepared by the customer.

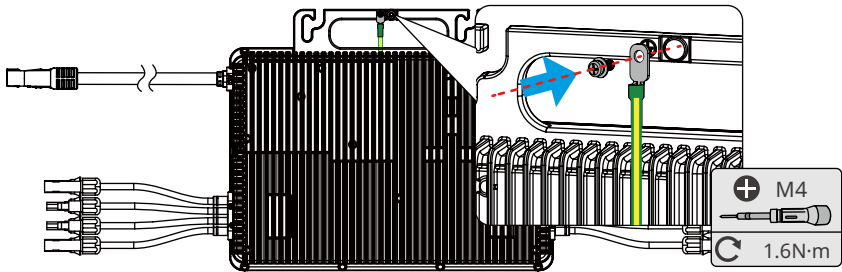
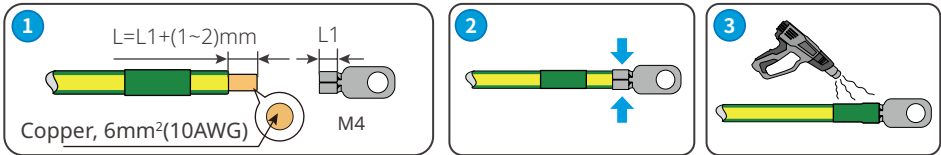

6.4 Connecting the AC Output Cable

WARNING

Do not connect loads between the inverter and the AC switch directly connected to the inverter.

An AC circuit breaker shall be installed on the AC side to make sure that the inverter can safely disconnect the grid when an exception happens. Select the appropriate AC circuit breaker in compliance with local laws and regulations. Recommended AC circuit breakers:

Inverter model	AC circuit breaker				
	For single inverter	For double inverters	For three inverters	For four inverters	For five inverters
GW1600-MIS	10A	25A	32A	40A	50A
GW1800-MIS	16A	25A	32A	40A	-
GW2000-MIS	16A	25A	32A	50A	-

Select and Install RCD depending on local laws and regulations. Type A RCDs (Residual Current Monitoring Device) can be connected to the inverter for protection when the DC component of the leakage current exceeds the limit value. For the system with a power below 30kW, it is recommended to use an RCD with a specification of 300mA. For the system with a power above 30kW, an RCD specification of 10mA per kVA is recommended.

WARNING

- Pay attention to the silkscreens L, N and PE on the AC connector. Connect the wires to the corresponding terminals. The inverter may be damaged if the wires are connected inappropriately.
- Make sure that the whole cable cores are inserted into the AC connector. No part of the cable core can be exposed.
- Make sure that the cables are connected securely. Otherwise, the connector may be too hot to damage the inverter when the inverter is working.
- Seal the AC connector using a sealing plug when it is not to be used. Otherwise, the ingress protection rating will be influenced.
- The AC cable can be purchased from the manufacturer or be prepared by the customer. Recommended specifications: 6mm² or 10AWG.

The number of micro inverters on each AC branch shall not exceed the limit below.

Maximum number per branch		
GW1600-MIS	GW1800-MIS	GW2000-MIS
5	4	4

Method I

Method I is suitable for T shape AC connector type II.

Step 1 Prepare the AC cable.

Step 2 Disassemble the T shape AC connector.

Step 3 Connect the crimped cable to the T shape AC connector.

Step 4 Install the T shape AC connector on the micro inverter securely.

Step 5 Seal the last connector and fix the AC cables using cable ties.

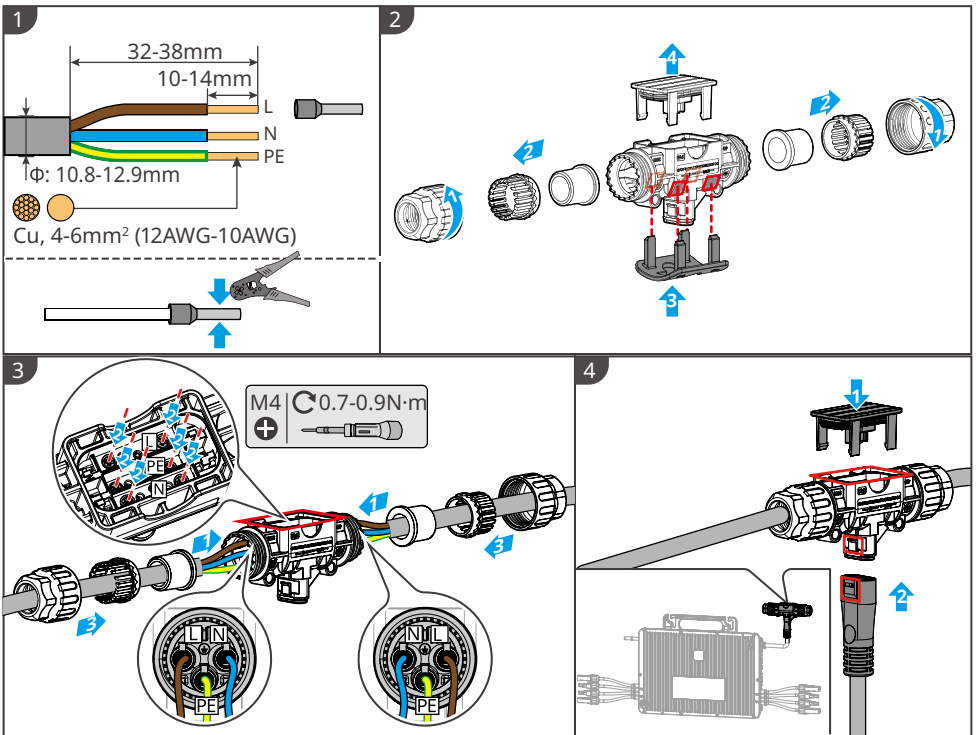

5

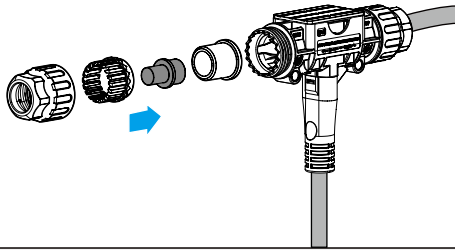

Method II

Method II is suitable for T shape AC connectors type I and AC connectors with 2.3 meters cable.

Step 1 Connect the AC connectors with cable to the T-shape AC connector, ensuring that the cable connections are secure.

Step 2 Fix the AC cables using cable ties.

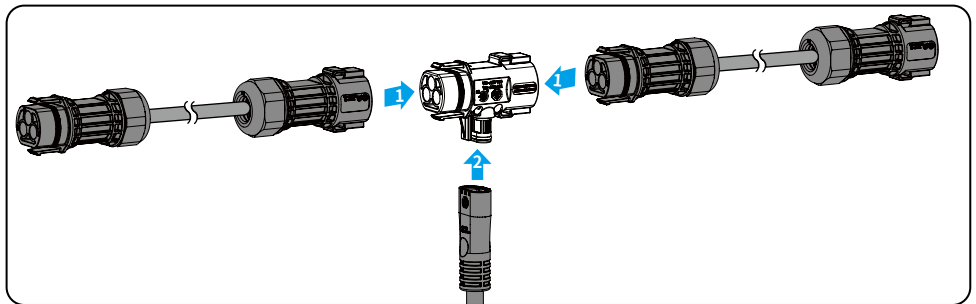
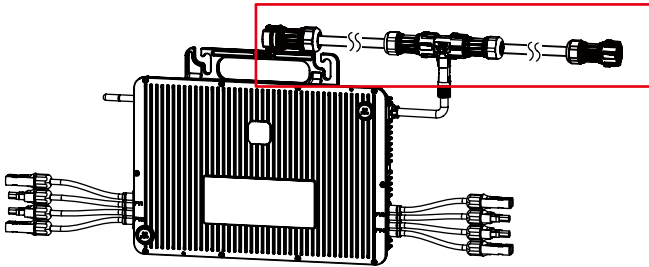

Method III

Method III is suitable for T shape AC connectors type I and AC connectors without cable.

Step 1 Prepare the AC cable.

Step 2 Disassemble the AC connector and connect the crimped cable to the AC connector.

Step 3 Install the AC connector on the micro inverter securely.

Step 4 Seal the last connector and fix the AC cables using cable ties.

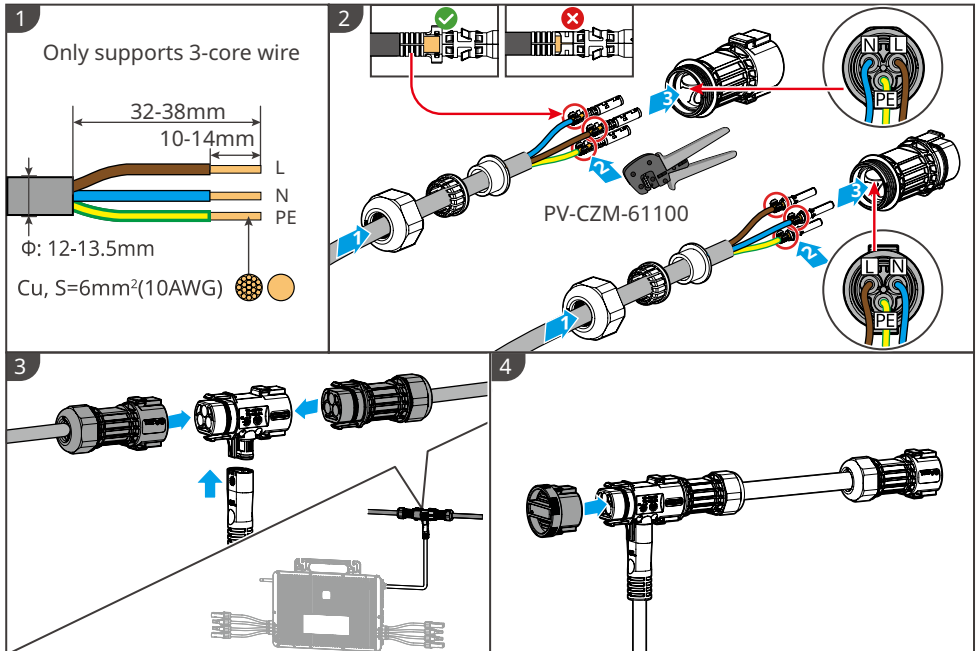

6.5 Connecting the PV Input Cable

⚠ DANGER

1. Confirm the following information before connecting the PV module to the inverter. Otherwise, the inverter may be damaged permanently or even cause fire and cause personal and property losses.
 - Make sure that the max short circuit current and the max input voltage per MPPT are within the permissible range.
 - Make sure that the positive pole of the PV module connects to the PV+ of the inverter. And the negative pole of the PV module connects to the PV- of the inverter.
2. Do not plug or unplug the connectors when the inverter is running.

⚠ WARNING

1. Connect the PV cables using the Staubli MC4 PV connectors. The manufacturer shall not be liable for the damage if other connectors are used.
2. The PV modules cannot be grounded. Ensure the minimum isolation resistance of string to the ground meets the minimum isolation resistance requirements before connecting the PV module to the inverter.
3. Connect the connectors of the same PV module to the same pair of PV connectors on the inverter.
4. Recommended PV module specifications:
GW1600-MIS: 0W~540W; 1800-MIS: 0W~600W; 2000: 0W~670W.
5. DC extension cable can be purchased from the manufacturer or be prepared by the customer. Recommended specifications: 4-6mm²(12AWG-10AWG).

NOTICE

Seal the PV connectors using waterproof covers when they are not to be used. Otherwise, the ingress protection rating will be influenced.

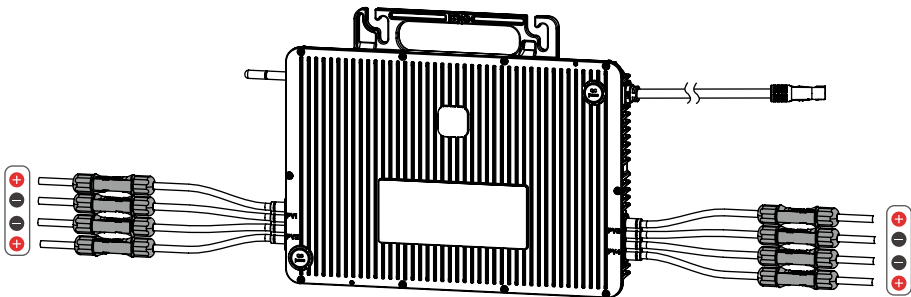

1

7-8mm
Φ: 5.9-8.8mm
7-8mm

Copper, $4\text{mm}^2(12\text{AWG}) \leq S \leq 6\text{mm}^2(10\text{AWG})$

2

3

Click

YQK-70

4

5

$\leq 65\text{V}$ ✓

6

Click

7 Equipment Commissioning

7.1 Check Before Power ON

No.	Check Item
1	The product is firmly installed at a clean place that is well-ventilated and easy-to operate.
2	The PE, PV input, and AC output cables are connected correctly and securely.
3	Cable ties are intact, routed properly and evenly.
4	Unused ports and terminals are sealed.
5	The voltage and frequency at the connection point meet the inverter on-grid requirements.

7.2 Power On





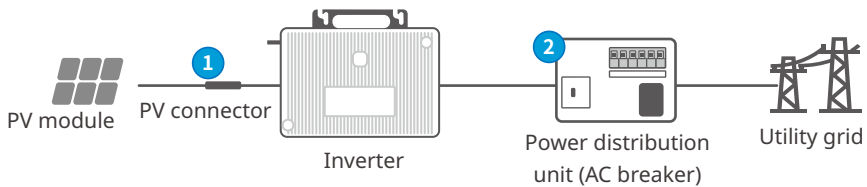



Step 1 Connect the PV connectors between the inverter and the PV module.

Step 2 Turn on the AC breaker between the inverter and the utility grid.



8 System Commissioning

8.1 Indicators

Indicator status	Description
	Slow blinking green = Equipment on and in the standby mode.
	Fast blinking green = equipment starting and in the self-check mode.
	Steady green = The four PV inputs are available, and the inverter is feeding power to the grid properly.
	<p>Blinking green and red = Not all PV inputs are available, but the inverter is still feeding power to the grid.</p> <p>The four blinks represent the status of four inputs PV1, PV2, PV3 and PV4 respectively. Red blinks indicating abnormal PV input, green blinks indicating normal PV input.</p> <p>Example: As shown on the left, PV1 is abnormal and PV2, PV3 and PV4 are normally working.</p>
	Single blinking red = Utility grid loss.
	Double blinking red = Utility grid fault.
	Steady red = Equipment fault.
	Fast blinking green and red = Updating software.

8.2 Setting Inverter Parameters via App

SolarGo app is a mobile application that communicates with the inverter via Bluetooth , WiFi or 4G. Commonly used functions are as follows:

1. Check the operating data, software version, alarms, etc.
2. Set grid parameters, communication parameters, etc.
3. Equipment maintenance.

Visit <https://en.goodwe.com> or scan the QR code to read the user manual.



SolarGo APP



SolarGo APP User Manual

8.3 Monitoring via SEMS Portal

SEMS Portal is a monitoring platform used to communicate with the inverter via WiFi, LAN, 4G, or GPRS. Commonly used functions:

1. Manage the organization or user information;
2. Add and monitor the power plant information;
3. Equipment maintenance.



SEMS Portal APP



SEMS Portal APP User Manual

9 Maintenance

9.1 Power Off the Inverter

DANGER

- Power off the inverter before operations and maintenance. Otherwise, the inverter may be damaged or electric shocks may occur.
- Delayed discharge. Wait until the components are discharged after power off.

Step 1 (optional) Send shutdown command to the inverter.

Step 2 Turn off the AC switch between the inverter and the utility grid.

Step 3 Disconnect the PV connectors between the inverter and the PV module.

9.2 Removing the Inverter

WARNING

- Make sure that the inverter is powered off.
- Wear proper PPE before any operations.

Step 1 Disconnect all the cables, including DC cables, AC cables and PE cables.

Step 2 Remove the inverter from the PV racking.

Step 3 Store the inverter properly. If the inverter needs to be used later, ensure that the storage conditions meet the requirements.

Removing the AC connector

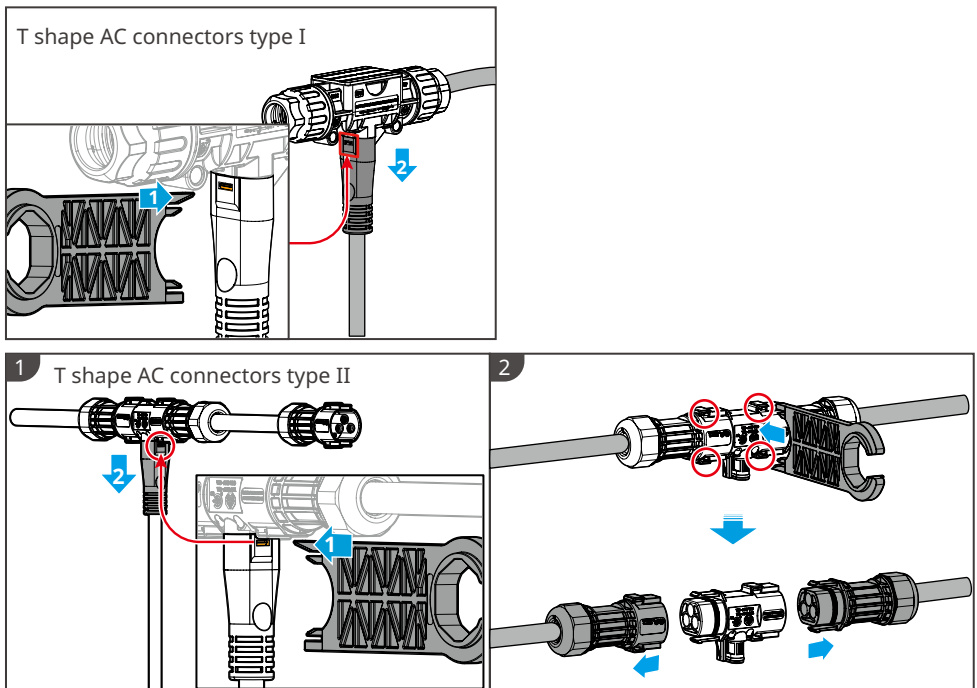

9.3 Disposing of the Inverter

If the inverter cannot work anymore, dispose of it according to the local disposal requirements for electrical equipment waste. The inverter cannot be disposed of together with household waste.

9.4 Troubleshooting

Perform troubleshooting according to the following methods. Contact the after-sales service if these methods do not work.

Collect the information below before contacting the after-sales service, so that the problems can be solved quickly.

1. Inverter information like serial number, software version, installation date, fault time, fault frequency, etc.
2. Installation environment, including weather conditions, whether the PV modules are sheltered or shadowed, etc. It is recommended to provide some photos and videos to assist in analyzing the problem.
3. Utility grid situation.

No.	Fault	Cause	Solutions
1	Utility Loss	<ol style="list-style-type: none"> 1. Utility grid power fails. 2. The AC cable is disconnected, or the AC breaker is off. 	<ol style="list-style-type: none"> 1. The alarm is automatically cleared after the grid power supply is restored. 2. Check whether the AC cable is connected and the AC breaker is on.
2	Grid Overvoltage	The grid voltage exceeds the allowed range, or the duration of high voltage exceeds the requirement of HVRT.	<ol style="list-style-type: none"> 1. If the problem occurs occasionally, the utility grid may be abnormal temporarily. The inverter will recover automatically after detecting that the utility grid is normal. 2. If the problem occurs frequently, check whether the grid voltage is within the permissible range. <ul style="list-style-type: none"> • Contact the local power company if the grid voltage exceeds the permissible range. • Modify the overvoltage protection threshold, HVRT or disable the overvoltage protection function after obtaining the consent of the local power company if the grid frequency is within the permissible range. 3. Check whether the AC breaker and the output cables are connected securely and correctly if the problem persists.

No.	Fault	Cause	Solutions
3	Grid Rapid Overvoltage	The grid voltage is abnormal or ultra-high.	<ol style="list-style-type: none"> 1. If the problem occurs occasionally, the utility grid may be abnormal temporarily. The inverter will recover automatically after detecting that the utility grid is normal. 2. If the problem occurs frequently, check whether the grid voltage is within the permissible range. <ul style="list-style-type: none"> • Contact the local power company if the grid voltage exceeds the permissible range. • Modify the grid overvoltage rapid protection threshold after obtaining the consent of the local power company if the grid voltage is within the permissible range.
4	Grid Undervoltage	The grid voltage is lower than the allowed range, or the duration of low voltage exceeds the requirement of LVRT.	<ol style="list-style-type: none"> 1. If the problem occurs occasionally, the utility grid may be abnormal temporarily. The inverter will recover automatically after detecting that the utility grid is normal. 2. If the problem occurs frequently, check whether the grid voltage is within the permissible range. <ul style="list-style-type: none"> • Contact the local power company if the grid voltage exceeds the permissible range. • Modify the undervoltage protection threshold, LVRT or disable the undervoltage protection function after obtaining the consent of the local power company if the grid frequency is within the permissible range. 3. Check whether the AC breaker and the output cables are connected securely and correctly if the problem persists.

No.	Fault	Cause	Solutions
5	Grid 10min Overvoltage	The moving average of grid voltage in 10min exceeds the range of safety requirements.	<ol style="list-style-type: none"> 1. If the problem occurs occasionally, the utility grid may be abnormal temporarily. The inverter will recover automatically after detecting that the utility grid is normal. 2. If the problem occurs frequently, check whether the grid voltage is within the permissible range. <ul style="list-style-type: none"> • Contact the local power company if the grid voltage exceeds the permissible range. • Modify the grid overvoltage rapid protection threshold after obtaining the consent of the local power company if the grid voltage is within the permissible range.
6	Grid Overfrequency	Utility grid exception. The actual grid frequency exceeds the requirement of the local grid standard.	<ol style="list-style-type: none"> 1. If the problem occurs occasionally, the utility grid may be abnormal temporarily. The inverter will recover automatically after detecting that the utility grid is normal. 2. If the problem occurs frequently, check whether the grid frequency is within the permissible range. <ul style="list-style-type: none"> • Contact the local power company if the grid frequency exceeds the permissible range. • Modify the overfrequency protection threshold or disable the overfrequency protection function after obtaining the consent of the local power company if the grid frequency is within the permissible range.

No.	Fault	Cause	Solutions
7	Grid Underfrequency	Utility grid exception. The actual grid frequency is lower than the requirement of the local grid standard.	<ol style="list-style-type: none"> 1. If the problem occurs occasionally, the utility grid may be abnormal temporarily. The inverter will recover automatically after detecting that the utility grid is normal. 2. If the problem occurs frequently, check whether the grid frequency is within the permissible range. <ul style="list-style-type: none"> • Contact the local power company if the grid frequency exceeds the permissible range. • Modify the underfrequency protection threshold or disable the underfrequency protection function after obtaining the consent of the local power company if the grid frequency is within the permissible range.
8	Grid Frequency Instability	Utility grid exception. The actual grid frequency change rate does not meet the requirement of the local grid standard.	<ol style="list-style-type: none"> 1. If the problem occurs occasionally, the utility grid may be abnormal temporarily. The inverter will recover automatically after detecting that the utility grid is normal. 2. If the problem occurs frequently, check whether the grid frequency is within the permissible range. <ul style="list-style-type: none"> • Contact the local power company if the grid frequency exceeds the permissible range. • Contact the dealer or the after-sales service if the grid frequency is within the permissible range.
9	Anti-islanding	The utility grid is disconnected. The utility grid is disconnected according to the safety regulations, but the grid voltage is maintained due to the loads.	<ol style="list-style-type: none"> 1. Check whether the utility grid is disconnected. 2. Contact the dealer or the after-sales service.

No.	Fault	Cause	Solutions
10	LVRT Undervoltage	Utility grid exception. The duration of the utility grid exception exceeds the set time of LVRT.	<ol style="list-style-type: none"> 1. If the problem occurs occasionally, the utility grid may be abnormal temporarily. The inverter will recover automatically after detecting that the utility grid is normal. 2. If the problem occurs frequently, check whether the grid frequency is within the permissible range. If not, contact the local power company. If yes, contact the dealer or the after-sales service.
11	HVRT Overvoltage	Utility grid exception. The duration of utility grid exception exceeds the set time of HVRT.	
12	Large DC of AC current L1	The DC component of the output current exceeds the safety range or default range.	<ol style="list-style-type: none"> 1. If the problem is caused by an external fault like a utility grid exception or frequency exception, the inverter will recover automatically after solving the problem. 2. If the problem occurs frequently and the PV station cannot work properly, contact the dealer or the after-sales service.
13	Large DC of AC current L2		
14	Low Insulation Res.	<ol style="list-style-type: none"> 1. The PV string is short-circuited to PE. 2. The PV system is in a moist environment and the cable is not well insulated to the ground. 	<ol style="list-style-type: none"> 1. Check whether the resistance of the PV string to PE exceeds 50kΩ. If no, check the short circuit point. 2. Check whether the PE cable is connected correctly. 3. If the resistance is lower than default value on rainy days, please reset the ISO. <p>In Australia or New Zealand, customers may be informed in the following ways once insulation fault occurs.</p> <ol style="list-style-type: none"> 1. The inverter is equipped with a buzzer that may sound continuously for 1 minute in the event of a fault. If the problem persists, the buzzer may sound every 30 minutes. 2. If the inverter is added to the monitoring platform, customers can set the alarm remind method as email reminding.

No.	Fault	Cause	Solutions
15	Anti Reverse power Failure	Abnormal fluctuation of load	<ol style="list-style-type: none"> 1. If the exception is caused by an external fault, the inverter will recover automatically after solving the problem. 2. If the problem occurs frequently and the PV station cannot work properly, contact the dealer or the after-sales service.
16	Flash Fault	The internal Flash storage is abnormal.	Disconnect the AC output switch and DC input switch, then connect them 5 minutes later. Contact the dealer or the after-sales service if the problem persists.
17	Cavity Overtemperature	<ol style="list-style-type: none"> 1. The inverter is installed in a place with poor ventilation. 2. The ambient temperature exceeds 60°C. 3. A fault occurs in the internal fan of the inverter. 	<ol style="list-style-type: none"> 1. Check the ventilation and the ambient temperature at the installation point. 2. If the ventilation is poor or the ambient temperature is too high, improve the ventilation and heat dissipation. 3. Contact the dealer or after-sales service if both the ventilation and the ambient temperature are normal.
18	BUS Overvoltage	<ol style="list-style-type: none"> 1. The PV voltage is too high. 2. The sampling of the inverter BUS voltage is abnormal. 	Disconnect the AC output switch and DC input switch, then connect them 5 minutes later. Contact the dealer or the after-sales service if the problem persists.
19	PV Input Overvoltage	The PV array configuration is not correct. Too many PV panels are connected in series in the PV string.	Check the serial connection of the PV array. Make sure that the open circuit voltage of the PV string is not higher than the maximum operating voltage of the inverter.
20	PV Continuous Hardware Overcurrent	<ol style="list-style-type: none"> 1. The PV configuration is not proper. 2. The hardware is damaged. 	Disconnect the AC output switch and DC input switch, then connect them 5 minutes later. Contact the dealer or the after-sales service if the problem persists.
21	PV Continuous Software Overcurrent	<ol style="list-style-type: none"> 1. The PV configuration is not proper. 2. The hardware is damaged. 	Disconnect the AC output switch and DC input switch, then connect them 5 minutes later. Contact the dealer or the after-sales service if the problem persists.
22	The string is connected reversely.	The PV string is connected reversely.	Check whether the PV modules are connected reversely.

9.5 Routine Maintenance

 **DANGER**

Power off the inverter before operations and maintenance. Otherwise, the inverter may be damaged or electric shocks may occur.

Maintaining Item	Maintaining Method	Maintaining Period
System Clean	Check the heat sink for foreign matter or dust.	Once 6-12 months
Electrical Connection	Check whether the cables are securely connected. Check whether the cables are broken or whether there is any exposed copper core.	Once 6-12 months
Sealing	Check whether all the terminals and ports are properly sealed. Reseal the cable hole if it is not sealed or too big.	Once a year

10 Technical Parameters

Technical Parameters	GW1600-MIS	GW1800-MIS	GW2000-MIS
Input			
Commonly used module power	320 to 535+	360 to 600+	400 to 670+
Max. Input Voltage (V)	65	65	65
MPPT Operating Voltage Range (V)	16~60	16~60	16~60
MPPT Voltage Range at Nominal Power (V)	27~60	30~60	33~60
Start-up Voltage (V)	22	22	22
Nominal Input Voltage (V)	42	42	42
Max. Input Current (A)	4 × 16	4 × 16	4 × 16
Max. input Short Circuit Current (A)	4 × 25 (Brazil: 4 × 20)	4 × 25 (Brazil: 4 × 20)	4 × 25 (Brazil: 4 × 20)
Number of MPP Trackers	4	4	4
Number of Inputs per MPPT	1	1	1
Max. module Isc(A)	4 × 20	4 × 20	4 × 20
DC port backfeed current(mA)	0	0	0
Output			
Max. continuous output power(VA)	1,600	1,800	2,000
Max. AC Active Power (W)	1,600	1,800	2,000
Max. AC Apparent Power (VA)	1,600	1,800	2,000
Nominal Power at 40°C (W)	1,600	1,800	2,000
Max. Power at 40°C (Including AC Overload) (W)	1,600	1,800	2,000
Nominal Output Voltage(V)	L/N/ PE,220/230/240	L/N/ PE,220/230/240	L/N/ PE,220/230/240
Output Voltage Range (V) ^{*1}	180~275	180~275	180~275
Nominal Output Frequency(Hz)	50/60	50/60	50/60
AC Grid Frequency Range (Hz) ^{*1}	50/60 ±5	50/60 ±5	50/60 ±5
Max. Output Current (A)	7.27@220 V 6.96@230 V 6.67@240 V	8.18@220 V 7.83@230 V 7.5@240 V	9.09@220 V 8.7@230 V 8.33@240 V
Max. continuous output current(A)	7.27@220 V 6.96@230 V 6.67@240 V	8.18@220 V 7.83@230 V 7.5@240 V	9.09@220 V 8.7@230 V 8.33@240 V
Power Factor	~1 (Adjustable from 0.8 leading to 0.8 lagging)	~1 (Adjustable from 0.8 leading to 0.8 lagging)	~1 (Adjustable from 0.8 leading to 0.8 lagging)
Max. Total Harmonic Distortion	<3%	<3%	<3%
Max. units per 4mm ² branch ^{*2}	2	2	2
Max. units per 6mm ² branch ^{*2}	4	4	4

Technical Parameters	GW1600-MIS	GW1800-MIS	GW2000-MIS
Max. Output Fault Current (Peak and Duration) (A)	45 (at 2μs)	45 (at 2μs)	45 (at 2μs)
Inrush Current (Peak and Duration) (A)	50 (at 10μs)	50 (at 10μs)	50 (at 10μs)
Max. Output Overcurrent Protection (A)	10	10	10
AC port backfeed current (mA)	0	0	0
Efficiency			
Max. Efficiency	96.4%	96.4%	96.4%
European Efficiency	94.0%	94.0%	94.0%
Nominal MPPT efficiency	99.8%	99.8%	99.8%
Night power consumption (W)	0.05	0.05	0.05
General Data			
Operating Temperature Range (°C) ^{*3}	-40~65	-40~65	-40~65
Derating Temperature (°C)	45	45	45
Storage Temperature (°C)	-40~85°C	-40~85°C	-40~85°C
Cooling Method	Natural convection	Natural convection	Natural convection
Weight (kg)	6	6	6
Dimensions (W × H × D mm)	330.5 × 266.7 × 42.5	330.5 × 266.7 × 42.5	330.5 × 266.7 × 42.5
Ingress Protection Rating	IP67	IP67	IP67
DC Connector	Staubli MC4	Staubli MC4	Staubli MC4
Relative Humidity	0~100%	0~100%	0~100%
Max. Operating Altitude (m)	2000	2000	2000
Noise Emission (dB)	<30dB	<30dB	<30dB
Environmental Category	4K4H	4K4H	4K4H
Pollution Degree	III	III	III
Overvoltage Category	DC II / AC III	DC II / AC III	DC II / AC III
Protective Class	I	I	I
The Decisive Voltage Class (DVC)	PV:C AC:C COM:A	PV:C AC:C COM:A	PV:C AC:C COM:A
Active Anti-islanding Method	AFDPF + AQDPF ^{*4}	AFDPF + AQDPF ^{*4}	AFDPF + AQDPF ^{*4}
Country of Manufacture	China	China	China
Features			
Communication	Built-in Wi-Fi and Bluetooth	Built-in Wi-Fi and Bluetooth	Built-in Wi-Fi and Bluetooth
Topology	Galvanically Isolated HF Transformer	Galvanically Isolated HF Transformer	Galvanically Isolated HF Transformer
Monitoring	SEMS	SEMS	SEMS
Protection	PV Insulation Resistance Detection PV Reverse Polarity Protection Anti-islanding Protection AC Overcurrent Protection AC Short Circuit Protection AC Overvoltage Protection Type III AC Surge Arrester		

Technical Parameters	GW1600-MIS	GW1800-MIS	GW2000-MIS
Warranty	12 Years Standard ; 25 Years Optional	12 Years Standard ; 25 Years Optional	12 Years Standard ; 25 Years Optional
Compliance	EN 62109-1:2010, EN 62109-2:2011, IEC 62109-1:2010, IEC 62109-2:2011, UTE C15-712-1:2013, DIN VDE 0126-1-1:2013 ,ENIEC 61000-6-3:2021, cEN 61000-6-3:2007+A1:2011+AC:2012, ENIEC 61000-6-4:2019, EN 61000-6-4:2007+A1:2011, AS/NZS 61000.6.3:2012, cAS/NZS 61000.6.4:2020, BS EN IEC 61000-6-3:2021, BS EN 61000-6-3:2007+A1:2011, BS ENIEC 61000-6-4:2019, BS EN 61000-6-4:2007+A1:2011, EN 61000-2-2:2002+A2:2019, IEC 61000-2-2:2018(ed.2.2), EN IEC 61000-6-1:2019, EN 61000-6-1:2007, EN IEC 61000-6-2:2019, EN 61000-6-2:2005+AC:2005, BS ENIEC 61000-6-1:2019, BS EN IEC 61000-6-2:2019		
*1: Nominal voltage/frequency range can be extended beyond nominal if required by the utility. *2: Limits may vary. Refer to local requirements to define the number of microinverters per branch in your area. *3: The inverter may enter to power de-grade mode under poor ventilation and heat dissipation installation environment. *4: AFDPF: Active Frequency Drift with Positive Feedback, AQDPF: Active Q Drift with Positive Feedback.			

11 Appendix

Installation Map Reference

User information:	Panel model:						Sheet_	N 
	Inverter model:							
Row 1	Column 1	Column 2	Column 3	Column 4	Column 5	Column 6	Column 7	
Row 2								
Row 3								
Row 4								
Row 5								
Row 6								
Row 7								
Row 8								
Row 9								
Row 10								



Official Website

GoodWe Technologies Co.,Ltd.

 No. 90 Zijin Rd., New District, Suzhou, 215011, China

 www.goodwe.com

 service@goodwe.com



Local Contacts